Synchronous Buck-Boost DC/DC Regulator

Features

- Synchronous rectification: Up to 95% efficiency
- Single inductor
- Fixed frequency operation with battery voltages above, below or equal to the output
- Quiescent current: 1mA (50uA low power mode: mode pin high)
- Up to 600mA continuous output current
- 1.8V to 5.5V input and output voltage range
- Programmable oscillator frequency from 350kHz to 1.5MHz
- No Schottky Diodes required
- V_{OUT} disconnected from V_{IN} during shutdown
- Shutdown current: $I_Q < 1\mu A$
- Package: small thermally enhanced 10-pin MSOP

Application

- Digital cameras and Wireless handsets
- Palmtop computers
- Handheld instruments
- MP3/MP4 players

Description

The UCT4802 is high efficiency, fixed frequency, Buck-Boost DC/DC converters which operates from input voltages above, below or equal to the output voltage. The devices are suitable for single lithium-ion, multicell alkaline or NiMH applications where the output voltage is within the battery voltage range.

The switching frequencies up to 1.5 MHz could be fixed by employing an external resistor, and the oscillator could be synchronized to an external clock. the quiescent current is 1mA, and this feature maximizing the battery life in portable applications.

Other features include a 1 μA shutdown, soft-start control, thermal shutdown and current limit. The UCT4802 converters are available in the 10-pin thermally enhanced MSOP packages (or upon request).



Typical Applications

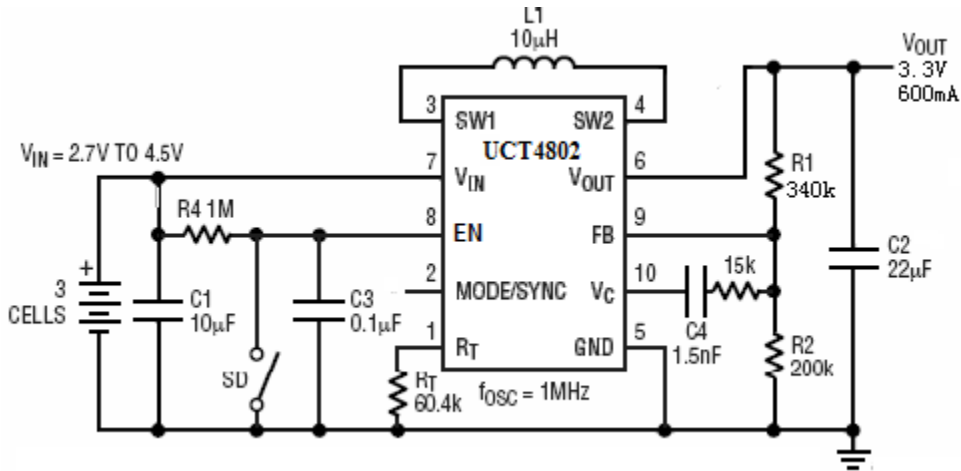

Absolute Maximum Ratings

- V_{IN} - 0.3 V ~ + 6 V
- $V_{RT}, FB, SHDN/SS, SYNC$ - 0.3 V ~ + 6 V
- V_{SW} - 0.3 V ~ + 6 V
- V_{OUT} - 0.3 V ~ + 6 V
- Operating Temperature Range - 40°C ~ + 85°C
- Lead Temperature (Soldering 10 sec.) + 300°C
- Storage Temperature Range - 65°C ~ + 150°C

Pin Assignment

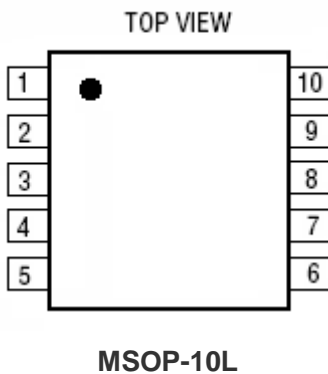

PIN NUMBER MSOP-10	PIN NAME	FUNCTION
1	R_T	Program the Oscillator Frequency
2	MS	MODE/SYNC
3	SW1	Switch 1
4	SW2	Switch 2
5	GND	Ground
6	V_{OUT}	Output
7	V_{IN}	Input
8	EN	ON/OFF Control (High Enable)
9	FB	Feedback
10	V_C	Error Amp Output

Electrical Characteristics

Operating Conditions: $T_A=25^{\circ}\text{C}$, $V_{IN}=3.6\text{V}$ unless otherwise specified.

PARAMETER	CONDITIONS	MIN	TYP	MAX	UNITS
Input Start-Up Voltage			1.8	1.9	V
Input Operating Range		1.8		5.5	V
Output Voltage Adjust Range		2.5		5.5	V
Feedback Voltage		1.200	1.212	1.220	V
Quiescent Current, Shutdown	EN=0V, Not Including Switch Leakage		0.1	1	μA
Quiescent Current, Active	$V_C=0\text{V}$, SYNC=0V		1		mA
NMOS Switch Leakage	Switches B and C		0.1	5	μA
PMOS Switch Leakage	Switches A and D			10	μA
NMOS Switch Resistance	On Switches B and C		0.19		Ω
PMOS Switch Resistance	On Switches A and D		0.22		Ω
Input Current Limit		1			A
Maximum Duty Cycle	Boost (% Switch C On)	55	75		%
	Buck (% Switch A On)	100			%
Minimum Duty Cycle				0	%
Frequency Accuracy		0.8	1	1.4	MHz
SYNC Input High		2			V
SYNC Input Low				0.4	
SYNC Input Current	$V_{\text{SYNC}}=5.5\text{V}$		0.01	1	μA
Error Amp AVOL			90		dB
Error Amp Source Current			1.5		μA
Error Amp Sink Current			380		A
EN Input High	When IC is Enabled	1.8			V
EN Input Low				0.4	
EN Threshold	When EA is at Maximum Boost Duty Cycle		2.2		V
EN Input Current	$V_{\text{EN}}=5.5\text{V}$		0.01	1	μA

Pin Description

R_T (Pin 1): Timing Resistor to Program the Oscillator Frequency. The programming frequency range is 300kHz to 2MHz.

$$f_{\text{OSC}} = \frac{6 \cdot 10^{10}}{R_T} \text{Hz}$$

Mode (Pin 2): Synchronization of the internal oscillator. A clock frequency of twice the desired switching frequency and with a pulse width between 100ns and 2μs is applied. The oscillator free running frequency is set slower than the desired synchronized switching frequency to guarantee sync. The oscillator RT component value required is given by:

$$R_T = \frac{8 \cdot 10^{10}}{f_{\text{SW}}}$$

Where f_{SW} = desired synchronized switching frequency.

SW1 (Pin 3): Switch Pin Where the Internal Switches A and B are Connected. Connect inductor from SW1 to SW2. An optional Schottky diode can be connected from SW1 to ground. Minimize trace length to keep EMI down.

SW2 (Pin 4): Switch Pin Where the Internal Switches C and D are connected. For applications with output voltages over 4.3V, a Schottky diode is required from SW2 to VOUT to ensure the SW pin does not exhibit excess voltage.

GND (Pin 5): Signal and Power Ground for the IC.

V_{OUT} (Pin 6): Output of the Synchronous Rectifier. A filter capacitor is placed from VOUT to GND.

V_{IN} (Pin 7): Input Supply Pin, Internal VCC for the IC. A ceramic bypass capacitor as close to the VIN pin and GND (Pin 5) is required.

EN (Pin 8): Combined Soft-Start and Shutdown. Grounding this pin shuts down the IC. Tie to >1.5V to enable the IC and > 1.8V to ensure the error amp is not clamped from soft-start. An RC from the shutdown command signal to this pin will provide a soft-start function by limiting the rise time of the VC pin.

FB (Pin 9): Feedback Pin. Connect resistor divider tap here. The output voltage can be adjusted from 2.5V to 5.5V. The feedback reference voltage is typically 1.212V.

V_C (Pin 10): Error Amp Output. A frequency compensation network is connected from this pin to the FB pin to compensate the loop.

Block Diagram

Output Ripple
(VIN=2.5V, VOUT=3.3V, IIOAD=80mA)

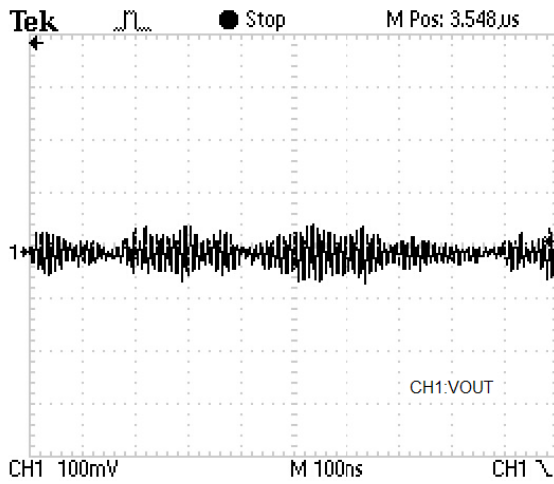

Output Ripple
(VIN=3.78V, VOUT=3.3V, IIOAD=100mA)

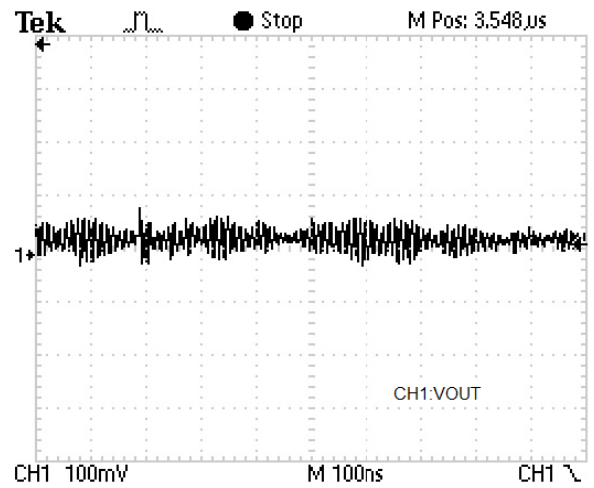

Output Ripple
(VIN=2.5V, VOUT=3.3V, IIOAD=80mA)

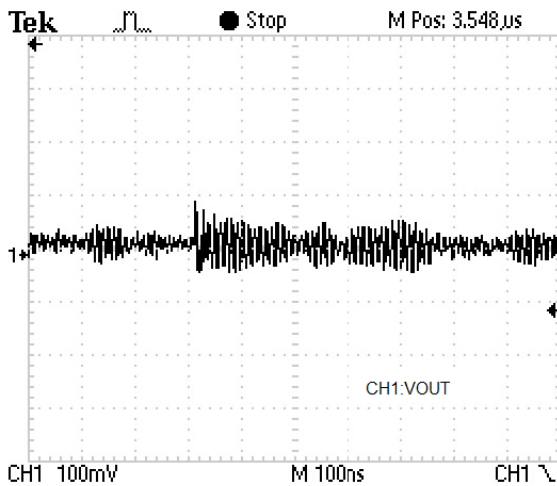

Typical Performance Characteristics

Efficiency vs. Output Current
(VOUT=3.2V)

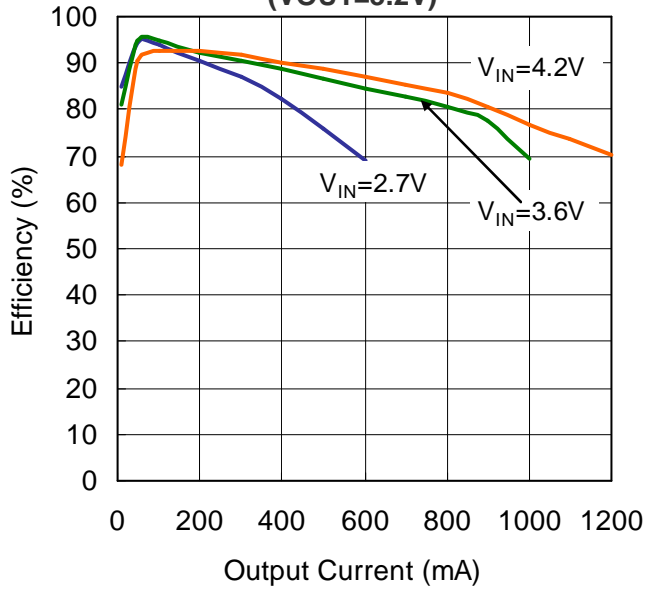

Efficiency vs. Output Current
(VOUT=5V)

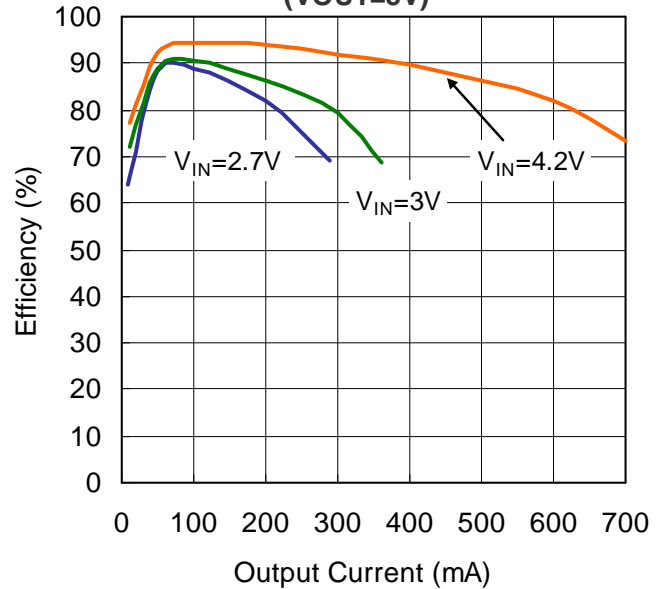

Output Voltage vs. Load Current
(VIN=3.6V, VOUT=3.2V)

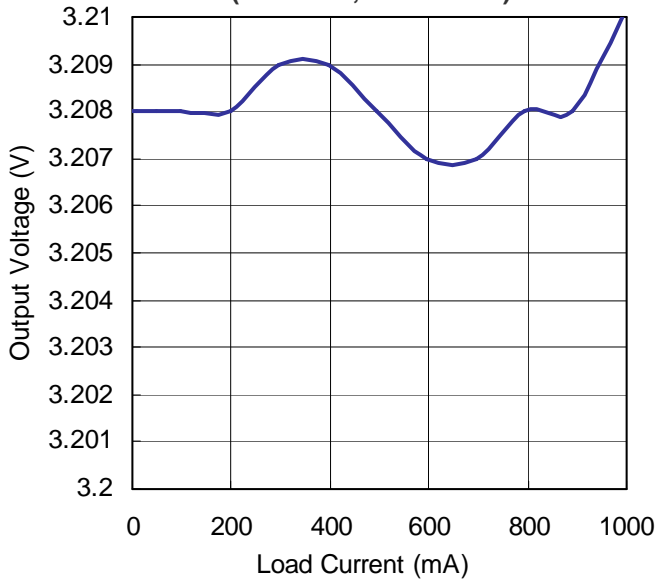

Output Voltage vs. Load Current
(VIN=4.2V, VOUT=5V)

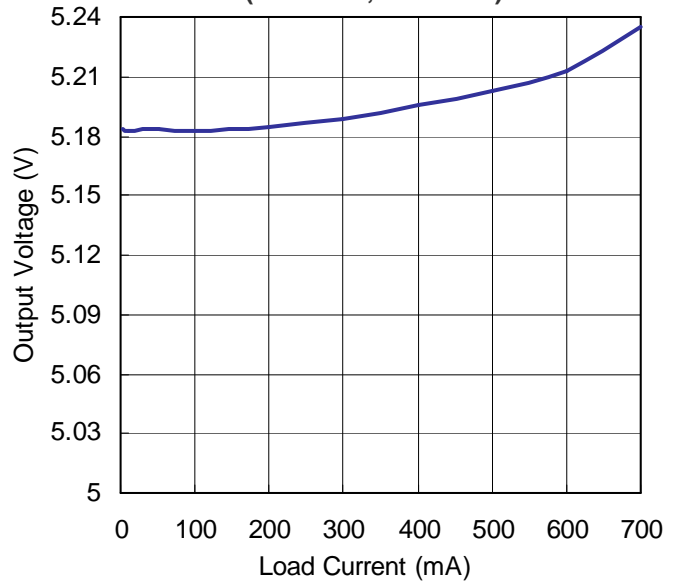

Output Ripple
(VIN=2.5V, VOUT=3.3V, IIOAD=80mA)

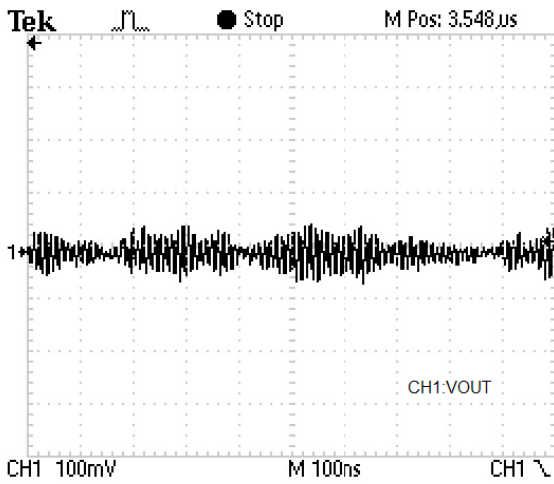

Output Ripple
(VIN=3.78V, VOUT=3.3V, IIOAD=100mA)

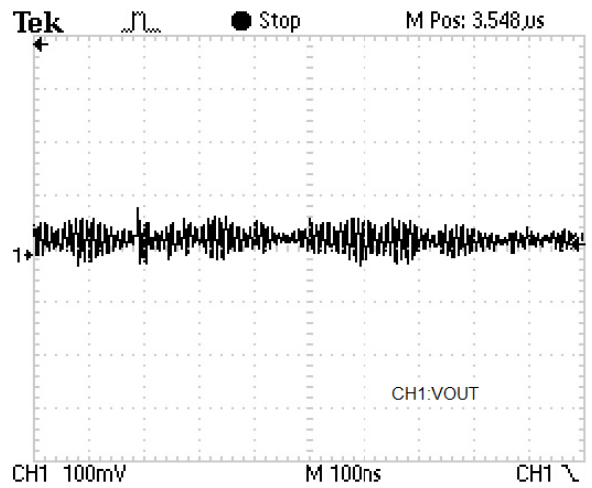

Output Ripple
(VIN=2.5V, VOUT=3.3V, IIOAD=80mA)

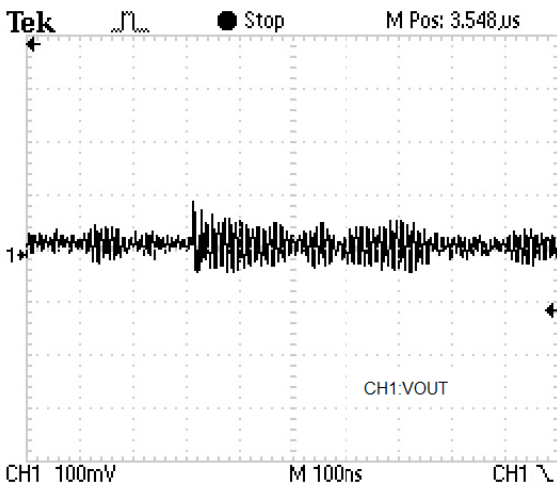

Typical Performance Characteristics

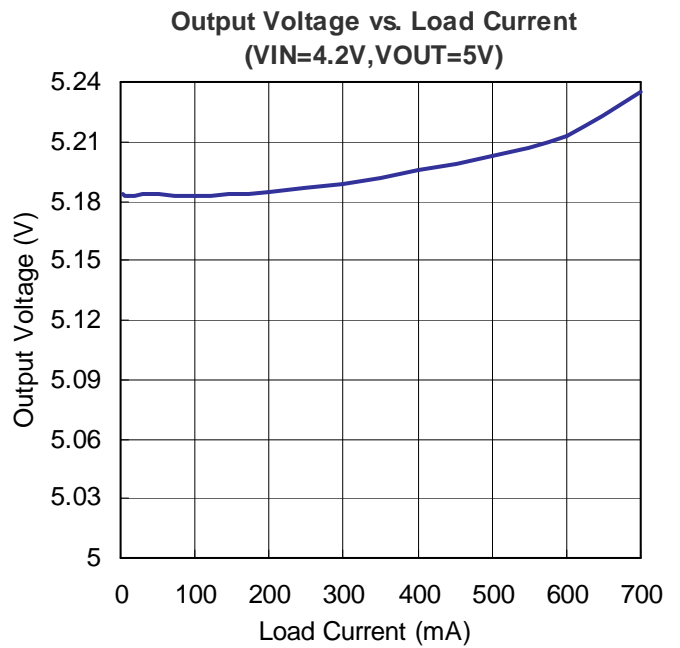
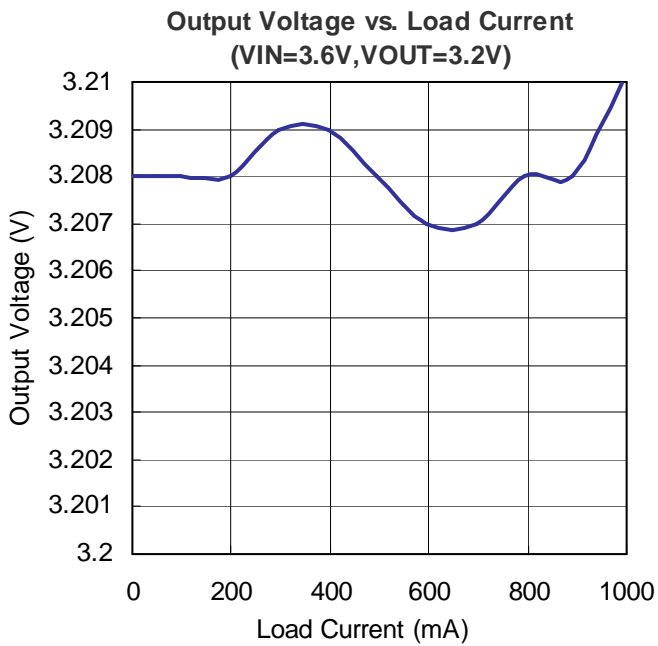
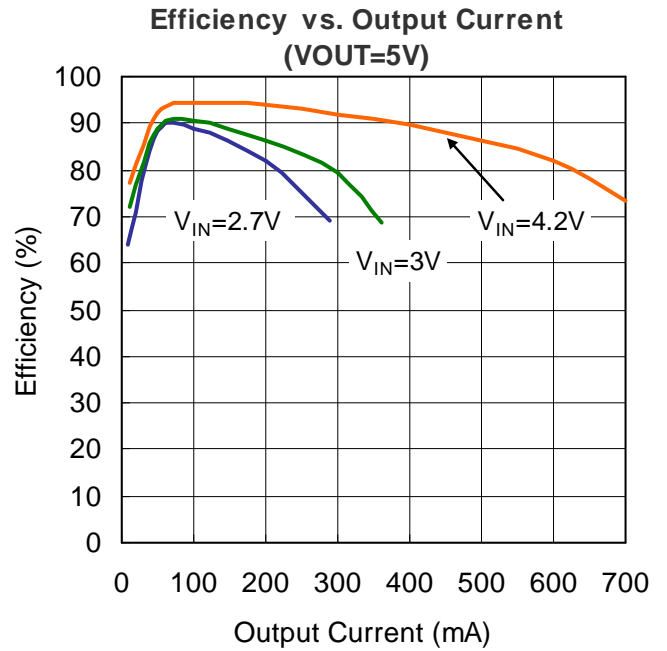
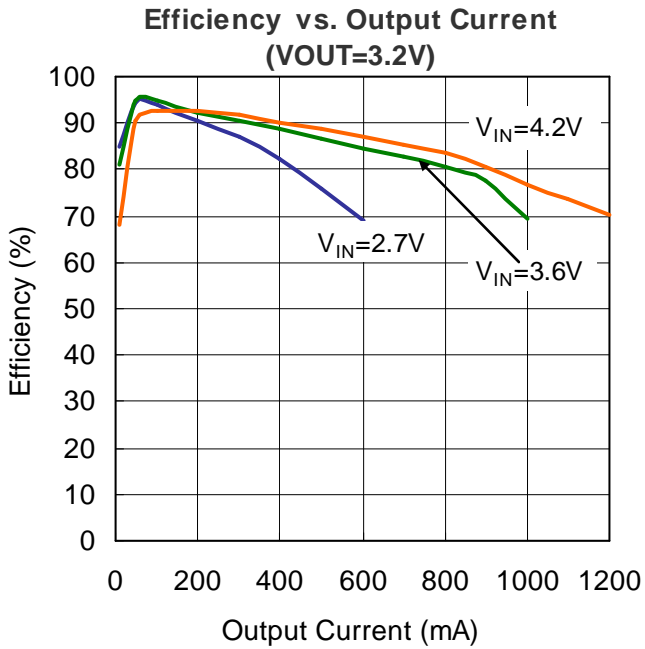

V_{OUT} = output voltage, V

$I_{OUT (MAX)}$ = maximum output load current

For high efficiency, choose an inductor with a high frequency core material, such as ferrite, to reduce core losses.

The inductor should have low ESR (equivalent series resistance) to reduce the I^2R losses, and must be able to handle the peak inductor current without saturating. Molded chokes or chip inductors usually do not have enough core to support the peak inductor currents in the 1A to 2A region. To minimize radiated noise, use a toroid, pot core or shielded bobbin inductor.

Output Capacitor Selection

The bulk value of the capacitor is set to reduce the ripple due to charge into the capacitor each cycle. The steady state ripple due to charge is given by:

$$\%Ripple_Boost = \frac{I_{OUT(MAX)} \cdot (V_{OUT} - V_{IN(MIN)}) \cdot 100}{C_{OUT} \cdot V_{OUT}^2 \cdot f} \%$$

$$\%Ripple_Buck = \frac{I_{OUT(MAX)} \cdot (V_{IN(MAX)} - V_{OUT}) \cdot 100}{C_{OUT} \cdot V_{IN(MAX)} \cdot V_{OUT} \cdot f} \%$$

where C_{OUT} = output filter capacitor, F

The output capacitance is usually many times larger in order to handle the transient response of the converter.

For a rule of thumb, the ratio of the operating frequency to the unity-gain bandwidth of the converter is the amount the output capacitance will have to increase from the above calculations in order to maintain the desired transient response.

The other component of ripple is due to the ESR (equivalent series resistance) of the output capacitor. Low ESR capacitors should be used to minimize output voltage ripple. For surface mount applications, Taiyo Yuden ceramic capacitors, AVX TPS series tantalum capacitors or Sanyo POSCAP are recommended.

Input Capacitor Selection

Since the V_{IN} pin is the supply voltage for the IC it is recommended to place at least a 4.7 μ F, low ESR bypass capacitor.

Packaging Information

MSOP-10 Package Outline Dimension

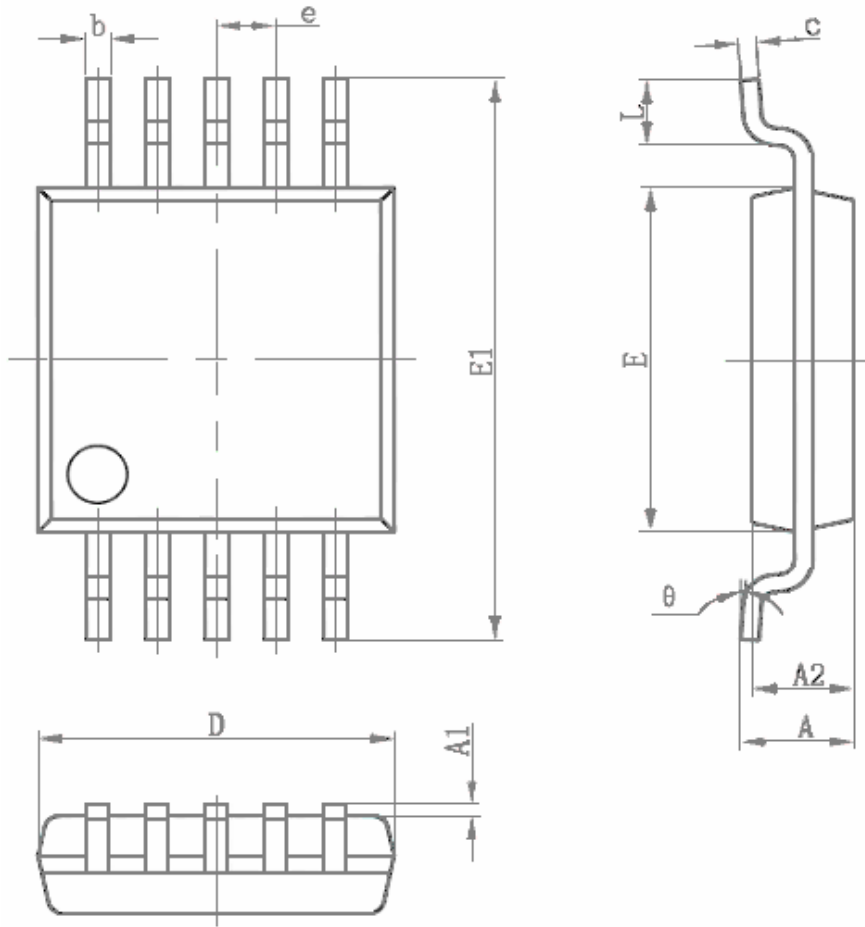

Symbol	Dimensions in Millimeters		Dimensions in Inches	
	Min	Max	Min	Max
A	0.820	1.100	0.032	0.043
A1	0.020	0.150	0.001	0.006
A2	0.750	0.950	0.030	0.037
b	0.180	0.280	0.007	0.011
c	0.090	0.230	0.004	0.009
D	2.900	3.100	0.114	0.122
e	0.50(BSC)		0.020(BSC)	
E	2.900	3.100	0.114	0.122
E1	4.750	5.050	0.187	0.199
L	0.400	0.800	0.016	0.031
	0°	6°	0°	6°